



MMA

Mixing amplifier



User manual

IMPORTANT SAFETY INSTRUCTIONS

CAUTION!

THIS PRODUCT UTILIZES A LASER. USE OF CONTROLS OR ADJUSTMENTS OR PERFORMANCE OF PROCEDURES OTHER THAN THOSE SPECIFIED HEREIN MAY RESULT IN HAZARDOUS RADIATION EXPOSURE. DO NOT OPEN COVERS AND DO NOT REPAIR YOURSELF. REFER SERVICING TO QUALIFIED PERSONNEL.

WARNING:

TO REDUCE THE RISK OF FIRE, ELECTRIC SHOCK OR PRODUCT DAMAGE, DO NOT EXPOSE THIS APPARATUS TO RAIN, MOISTURE, DRIPPING OR SPLASHING AND THAT NO OBJECTS FILLED WITH LIQUIDS, SUCH AS VASES, SHALL BE PLACED ON THE APPARATUS.



When using this electronic device, basic precautions should always be taken, including the following:

1. Read all instructions before using the product.
2. Do not use this product near water (e.g., near a bathtub, washbowl, kitchen sink, in a wet basement or near a swimming pool etc).
3. Use this device when you are sure that amplifier has a stable base and it is fixed securely.
4. This product, in combination with loudspeakers may be capable of producing sound levels that could cause permanent hearing loss. Do not operate for a long period of time at a high volume level or at a level that is uncomfortable. If you experience any hearing loss or ringing in the ears, you should consult with otorhinolaryngologists. The product should be positioned so that proper ventilation is maintained.
5. The product should be located away from heat sources such as radiators, heat vents, or other devices (including amplifiers) that produce heat.
6. The product should be connected to a power supply that is described in the operating instructions or are marked on the product. Replace the fuse only with one of the specified type, size and correct rating.
7. The power supply cord should be undamaged and never share an outlet or extension cord with other devices so that the outlet or extension cord's power rating is exceeded. Never leave device plugged into the outlet when it is not being used for a long period of time.
8. Care should be taken so that objects do not fall into, and liquids would not be spilled through, the enclosure's openings.
9. The product should be serviced by qualified service personnel if:
 - The power supply cord or the plug has been damaged.
 - Objects have fallen into or liquid has been spilled on the product.
 - The product has been exposed to rain.
 - The product has been dropped or the enclosure damaged.
10. There are some areas with high voltage inside, to reduce the risk of electric shock do not remove cover of the amplifier. The cover should be removed by the qualified personnel only.

3 Contents

CONTENTS:

<u>Before you start</u>	
Introductions	4
Features	4
<u>Operation</u>	
Front panel	5
Rear panel	5
Function description	6
Output terminal	9
<u>Controls and connectors</u>	
Connectors	10
Cable wiring examples	10
Block diagram	13
<u>Specifications</u>	
General specifications	14

Introduction

MMA five zone mixing amplifiers for commercial and industrial applications. Possibility to plug in music source module, 5 zone speaker lines, connector for page station 5X microphone, zone selecting, and low impedance speaker line, variety of microphone and line inputs makes these units universal for any kind of installation.

Features

- Six microphone inputs with gain control
- 3.5mm Jack AUX input
- Ready to plug in music source module
- Ready for paging microphone Page station 5X
- Priority input with priority on/off switch
- Phantom power. Switchable on all XLR inputs.
- Chime
- Graphic equalizer
- LINK IN, LINK OUT, AMP IN and PRE-AMP OUT connectors

5 Operation

Front Panel

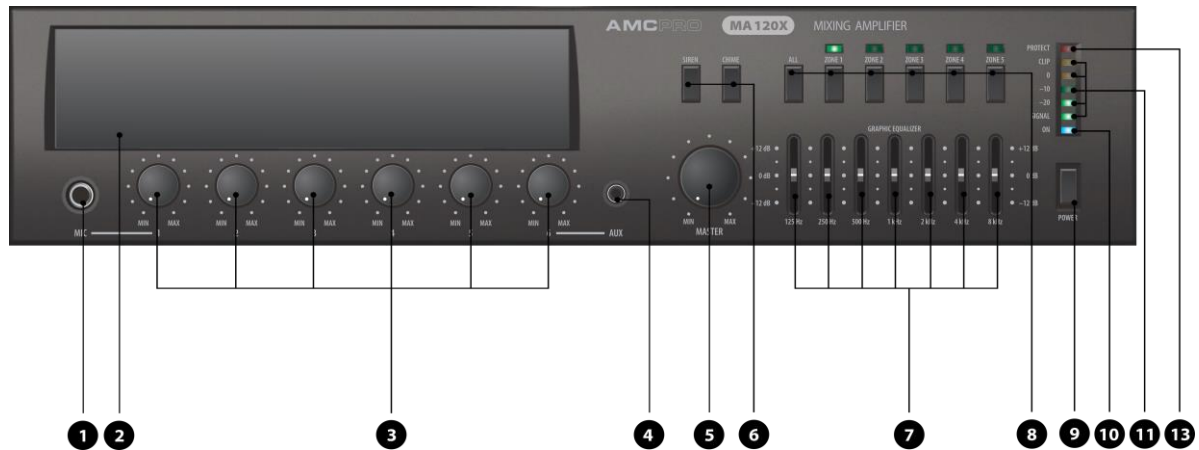

- | | |
|---------------------------------|--------------------------|
| 1. Front panel microphone input | 7. Equalizer |
| 2. Slot for music source module | 8. Zone selection switch |
| 3. Input volume control | 9. Power switch |
| 4. AUX input | 10. Power indicator |
| 5. Master volume control | 11. Signal indicator |
| 6. Chime and siren switch | 12. Protect indicator |

Rear Panel

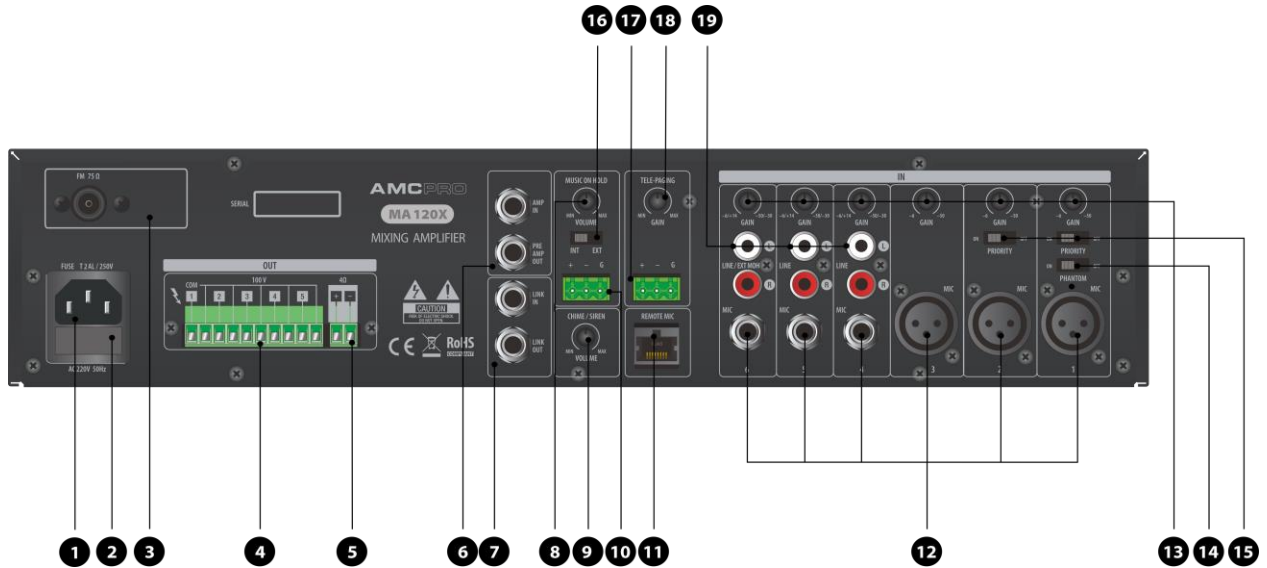

- | | |
|--------------------------------------|---|
| 1. Main power connector | 11. Remote microphone connector |
| 2. AC fuse holder | 12. Microphone inputs |
| 3. Antenna connectors | 13. Gain control |
| 4. 100V amplifiers output | 14. Phantom power switch |
| 5. 4Ω amplifiers output | 15. Priority switch |
| 6. AMP IN and PRE-AMP OUT connectors | 16. Music on hold audio source selector |
| 7. LINK IN and LINK OUT connectors | 17. Tele paging connector |
| 8. Music on hold volume control | 18. Tele paging volume control |
| 9. Chime/Siren level control | 19. Line inputs |
| 10. Music on hold audio output | |

Functions description

FRONT PANEL MICROPHONE INPUT

This balanced 6,3mm jack input is in parallel to first microphone input in the rear panel. The gain and phantom power for this input are selected by using gain control knob and phantom power switch located in the rear panel. Please note: don't use front and rear first microphone input at the same time.

SLOT FOR MUSIC SOURCE MODULE

This slot is designed to install music source module to amplifiers. Please find installation manual in page 8.

INPUT VOLUME CONTROL

These rotary knobs are for adjusting volume level of the audio inputs. All balanced XLR inputs are suitable for line level as well as microphone level audio signals, if corresponding input gain is adjusted. The input gain control is located in the rear panel.

SIREN AND CHIME SWITCH

There is designed siren and chime sound generator inside the amplifier. Press the siren or chime button located in the front panel to activate it. Audio level can be adjusted by using Chime/Siren level control located in the rear panel.

MASTER VOLUME CONTROL

This knob is designed to adjust main volume of the amplifier.

AUX INPUT

This stereo 3,5mm jack input is in parallel to sixth input in the rear panel. The gain potentiometer are located in the rear panel.

ALL ZONE SELECTION SWITCH

This switch activates all zones for broadcasting announcement or background music.

ZONE SELECTION SWITCH

These switches controls amplifier's output in order to broadcast announcement or background music to the desired zone.

EQUALIZER

Graphic equalizer allows to adjust sound frequency at 125Hz, 250Hz, 500Hz, 1kHz, 2kHz, 4kHz, and 8kHz points in ± 12 dB range.

POWER SWITCH

Use this switch to power on or off the amplifier. The power LED in the front panel lights up if the amplifier is powered on.

POWER INDICATOR

This LED indicates status of the main power. The LED lights up if the amplifier is powered on.

SIGNAL INDICATOR

LED in the front panel indicates audio signal of the amplifier.

PROTECT INDICATOR

This LED lights up for a few seconds after the amplifier is powered on and then turns off if the amplifier is not damaged. It is normal for the protection LED to fade slowly when the amplifier is powered off.

MAIN POWER CONNECTOR

Power connector is designed for main powers connecting to amplifier. This connector is combined with fuse holder.

AC FUSE HOLDER

Please use 2 A, 250 V fuse for amplifier MMA 120X, 4A, 250V fuse for amplifier MMA 240X, 6.3A, 250V fuse for amplifier MMA 360X and 8A, 250V fuse for amplifier MMA 480X.

100V AND 4Ω AMPLIFIERS OUTPUT

Use this connector to connect amplifier to the loudspeakers. There are two types of output: 100V and 4Ω. 100V output is designed for loudspeakers with built-in impedance matching transformer. 4Ω output suitable for speaker without 100V matching transformer. Please note: MMA480X amplifier have 100V output only!

CONNECTOR FOR PAGE STATION 5X MICROPHONE

This connector is suitable for page station 5X microphone. Don't connect any other devices to this connector, other vice amplifier and connected device will be damaged.

ANTENNA CONNECTORS

If amplifier is supplied without the music source module, this connector is not installed. Antenna connector is part of music source module, so connector is included to module package.

AMP IN AND PRE-AMP OUT CONNECTORS

PREAMPLIFIER OUTPUT - line level output directly from unit preamplifier. AMPLIFIER INPUT - line level input directly to device power amplifier. Preamplifier output and amplifier input are designed to insert signal processor such as equalizer or limiter. Please note that AMP IN and PRE-AMP are designed before the master potentiometer, so master doesn't affect audio level in these connectors. Please check block diagram to find location where connectors are inserted to amplifiers layout.

LINK IN AND LINK OUT CONNECTORS

LINK OUTPUT - line level output linked from unit preamplifier. LINK INPUT - line level input linked to device power amplifier. Please note that LINK IN and LINK OUT are designed before the equalizer and master potentiometer, so equalizer and master don't affect audio in these connectors. LINK IN and LINK OUT connectors are suitable to link audio signal from MMA to another amplifier or to audio recorded etc. Please check block diagram to find location where connectors are inserted to amplifiers layout.

MUSIC ON HOLD

Music on hold audio output produce audio signal from installed music source module or input sixth. The source and audio level can be selected by using switch and potentiometer located on rear panel.

CHIME/SIREN LEVEL CONTROL

Chime and siren audio level can be adjusted by using Chime/Siren level control.

TELE PAGING

This is balanced input for dynamic remote microphone. Balanced Phoenix connector.

MICROPHONE INPUT

This is balanced input with XLR and 6.3mm Jack connectors. Gain of this input can be adjusted by using gain control knob located above connector. The phantom power and priority can be activated for first two inputs separately by using phantom power and priority switch.

LINE INPUTS

Input 4, inputs 5 and input 6 have stereo RCA connectors for line level audio input. Stereo signal in these inputs are converted to mono.

GAIN CONTROL

This control allows you to precisely adjust the input level of the signal arriving at the rear-panel input connectors. For the microphone input at their fully counterclockwise position input gain is -6 dBu. At fully clockwise position, input gain is - 50dBu. For the live level input at their fully counterclockwise position input gain is +14dBu. At fully clockwise position, input gain is - 30dBu.

PHANTOM POWER SWITCH

Set phantom power switch to "ON" position to activate phantom power to all XLR inputs. Maximum phantom power voltage is +15V. To disable phantom power set switch to "off" position.

PRIORITY SWITCH

Microphone input 1 and input 2 can set as priority input. To activate the priority, please set priority switch to „on" position. To deactivate set to position „off".

Music source module installation manual

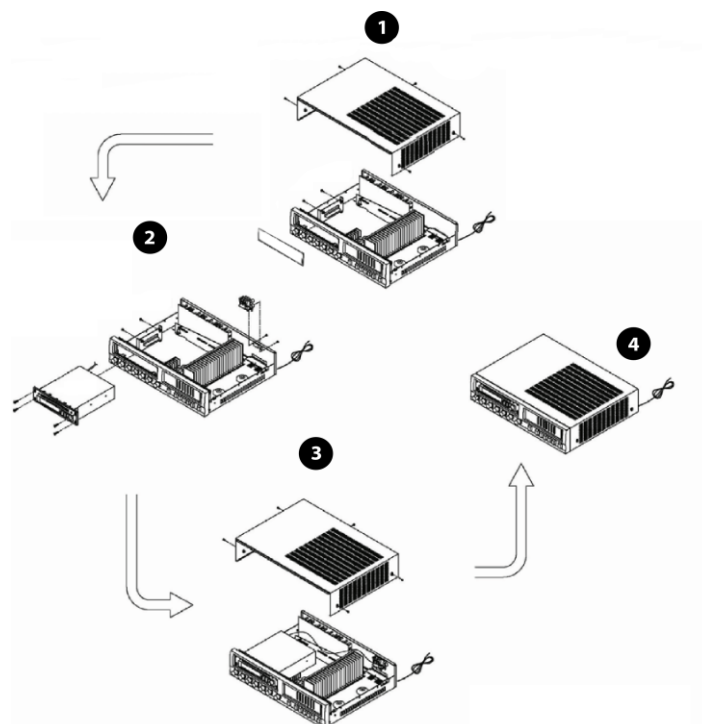

1. Unplug amplifier from the main power and remove the top and slot covers.
2. Insert module in to amplifier and mount the antenna connector in to rear panel if module have radio tuner.
3. Connect module cable in free connector located near the module slot in the main amplifier's PCB. Antenna cable should be connected to the antenna connector.
4. Fix module with the screws added into the module package and mount top amplifier's cover.

Bracket installation manual

Before the mounting amplifier to the rack stand, please fix mounting brackets to the amplifier by using two screws located in the sides of amplifier.

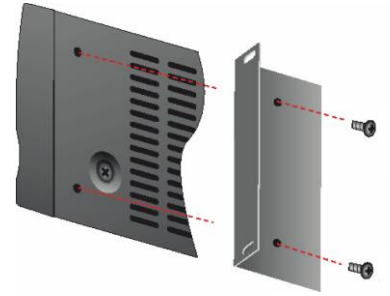

Output terminal

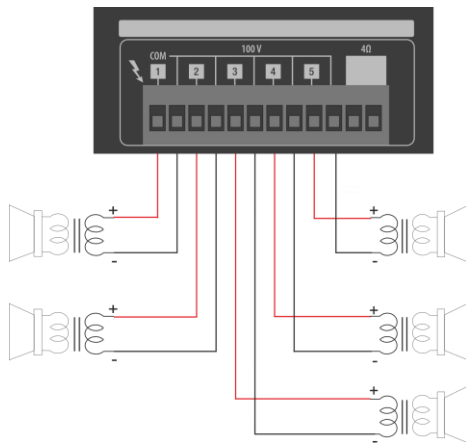

Hi impedance output

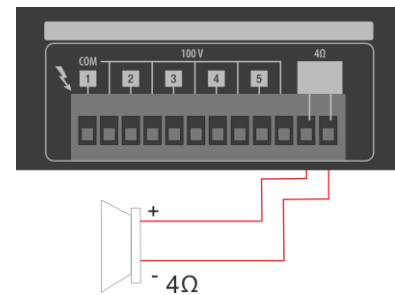

Low impedance output

Please note. Amplifiers output can run only one configuration at the same time. Operating amplifiers using 4 Ω and 70 or 100 volt concurrently may cause damage to the amplifier or connected speakers.

Remote MIC



MMA amplifier can be connected to remote paging microphone station Page station 5X by UTP CAT5 cable. Please note : This port is not network terminal. Do not connect amplifier or microphone to the to LAN. Maximum cable length 200m.

Connectors

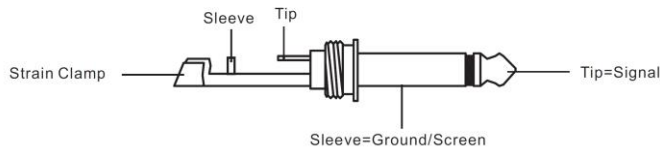

TS connector

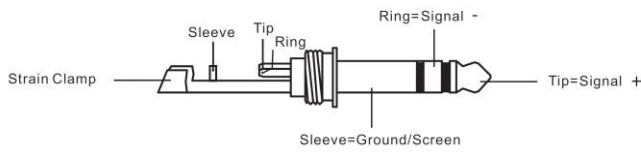

TRS connector

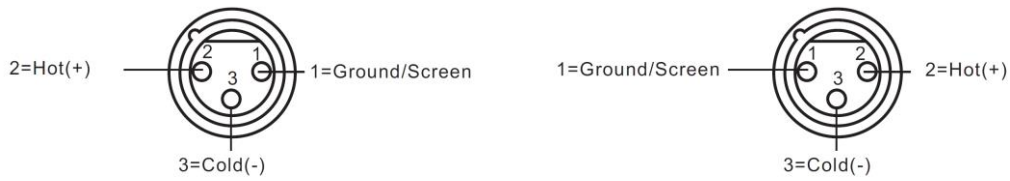

XLR male connector

XLR female connector

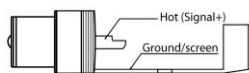

RCA connector

Cable wiring examples



Cable to balanced input from balanced output. TRS connectors.



Cable to unbalanced input from balanced output. TRS and TS connectors.



Cable to balanced input from unbalanced output. TS and TRS connectors.

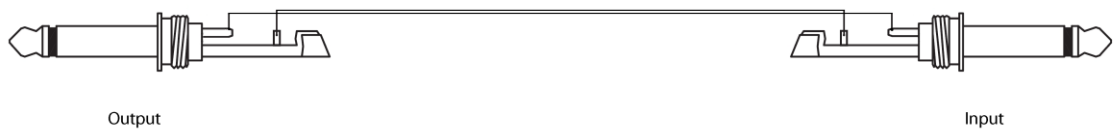

Cable to unbalanced input from unbalanced output. TS connectors.

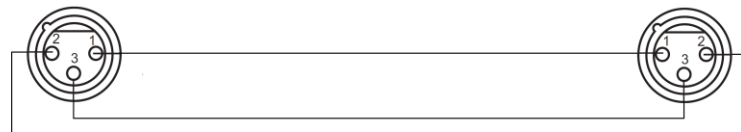

Cable to balanced input from balanced output. XLR connectors.

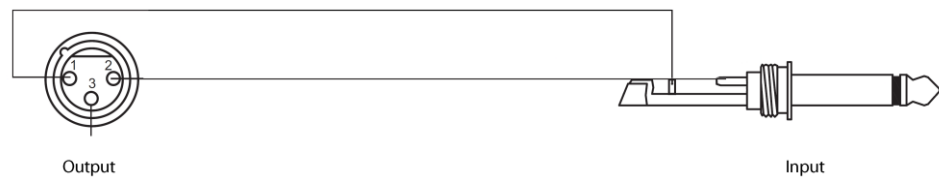

Cable to unbalanced input from balanced output. XLR and TS connectors.

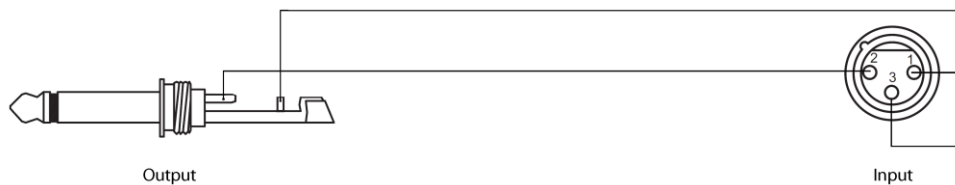

Cable to balanced input from unbalanced output. TS and XLR connectors.

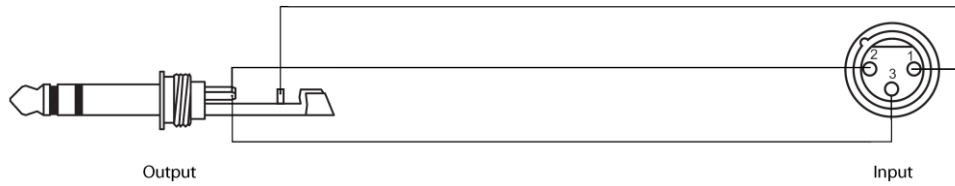

Cable to balanced input from balanced output. TRS and XLR connectors.



RCA cable.



Cable to unbalanced input from RCA output. RCA and TS connectors.

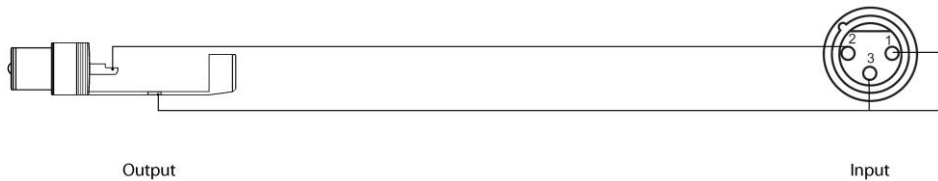

Cable to balanced input from RCA output. RCA and XLR connectors.

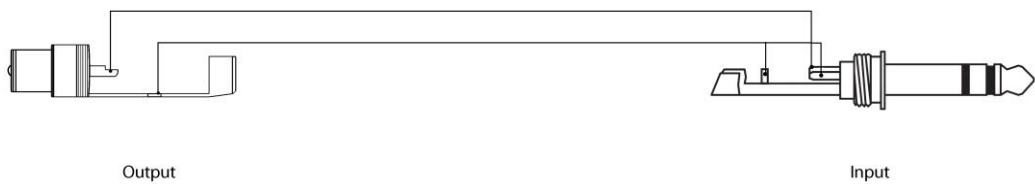

Cable to balanced input from RCA output. RCA and TRS connectors.



Cable to RCA input from balanced output. RCA and XLR connectors.



Cable to RCA input from balanced output. RCA and TRS connectors.

Block diagram

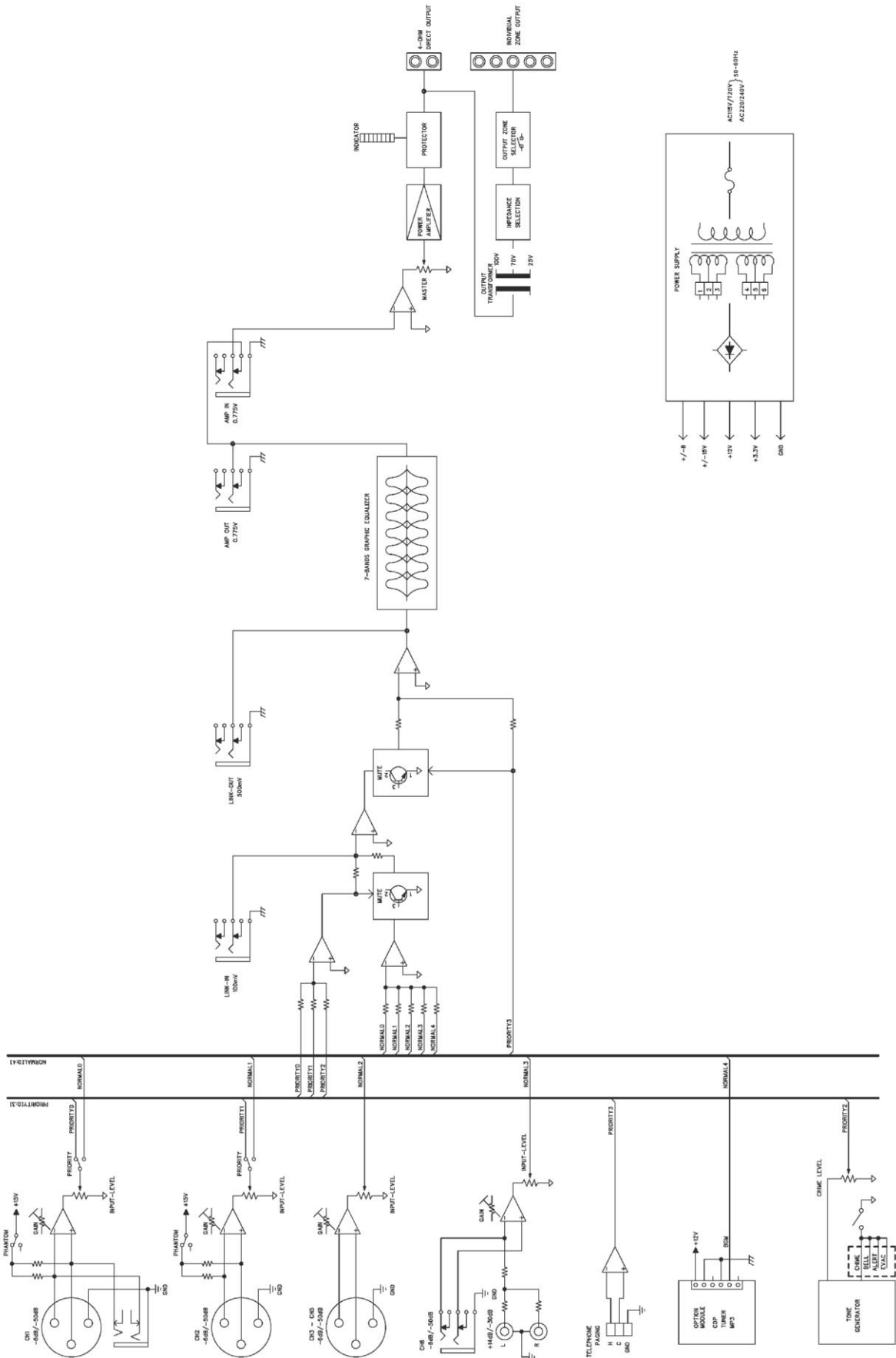

General specifications

	MMA 120X	MMA 240X	MMA 360X	MMA 480X
Power supply	AC 230 V, 50 Hz			
Output power	120 W	240 W	360 W	480 W
Phantom power voltage	15V			
Total harmonic distortions	< 0,5 %			
Microphone input sensitivity	-50dBu – -6 dBu			
RCA input sensitivity	-30dBu – 14 dBu			
Remote microphone sensitivity	-40dBu – 0dBu			
Link in sensitivity	-17 dBu			
Amp in sensitivity	0 dBu			
S/N ratio	75 dB			
Frequency response	80 Hz – 15 kHz			
Equalizer	125Hz,250Hz,500Hz,1kHz,2kHz,4kHz,8kHz \pm 12dB			
Cooling	Convection			
Indicators	Power, signal, protection			
Output	100 V, 70 V, 8 Ω			
Weight	9,76 kg	10,5 kg	8,3 kg	5,5 kg
Dimensions	420 mm (W) x 88 mm (H) x 320 mm (D)			

The specifications above are correct at the time of printing of this manual. For improvement purposes, all specifications for this unit, including design and appearance, are subject to change without prior notice

