

User
Manual

iLive 2x2
Wireless microphone system



Minimum
Maximum usage



Safety instructions

When using this electronic device, basic precautions should always be taken, including the following:

- 1 Read all instructions before using the product.
- 2 Do not use this product near water (e.g., near a bathtub, washbowl, kitchen sink, in a wet basement or near a swimming pool etc).
- 3 Use this device when you are sure that paging microphone has a stable base and it is fixed securely.
- 4 This product, in combination with loudspeakers and amplifier may be capable of producing sound levels that could cause permanent hearing loss. Do not operate for a long period of time at a high volume level or at a level that is uncomfortable. If you experience any hearing loss or ringing in the ears, you should consult with otorhinolaryngologists.
- 5 The product should be located away from heat sources such as radiators, heat vents, or other devices that produce heat.
- 6 The product should be connected to a power supply that is described in the operating instructions or are marked on the product.
- 7 The power supply should be undamaged and never share an outlet or extension cord with other devices. Never leave device plugged into the outlet when it is not being used for a long period of time.
- 8 Care should be taken that objects do not fall into liquids and liquids would not be spilled on the device.
- 9 The product should be serviced by qualified service personnel if:
 - The power supply or the plug has been damaged.
 - Objects have fallen into or liquid has been spilled on the product.
 - The product has been exposed to rain.
 - The product has been dropped or the enclosure damaged.
- 10 There are some areas with high voltage inside, to reduce the risk of electric shock do not remove cover of the microphone receiver or power supply. The cover should be removed by the qualified personnel only.

 <p>CAUTION</p> <p>RISK OF ELECTRIC SHOCK DO NOT OPEN</p>	<p>To reduce the risk of electric shock, do not remove screws. No user-serviceable parts inside. Refer servicing to qualified service personnel. To reduce the risk of fire, electric shock or product damage, do not expose this apparatus to rain, moisture, dripping or splashing and that no objects filled with liquids, such as vases, shall be placed on the apparatus.</p>
---	--



Table of contents

Before you start

Introduction.....	2
Features.....	2

Operation

Front panel.....	3
Rear panel.....	4
Handheld microphone.....	5
Body pack transmitter.....	5
Receiver operation.....	6
Handheld microphone operation.....	6-7
Body pack transmitter operation.....	7
Synchronization.....	8
Receiver's menu.....	9

Specifications

General specifications.....	14
-----------------------------	----



Before you start

iLive 2x2 - dual wireless receivers with 32 selectable channels and automatic channel targeting. Wireless microphone sets can be combined with handheld or body pack transmitter with variety of microphone selection to use with body pack.

FEATURES

- 2 x 32 selectable channels
- Automatic channel targeting ACT synchronization
- High brightness LCD display
- RF, AF level meter
- Digital volume and squelch control for each receiver
- Lock menu function
- Balanced XLR connector and unbalanced 6,3mm TS jack connector outputs. Jack/Jack cable included

Operation

Front Panel

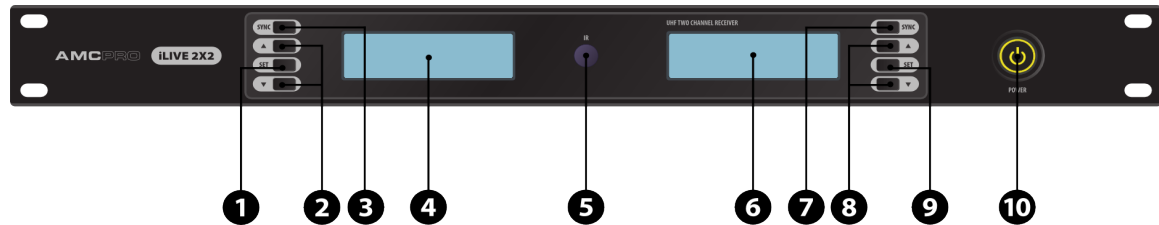

First receiver

1. SET button | 2. Navigation buttons | 3. SYNC button | 4. LCD display | 5. IR transmitter

Second receiver

6. LCD display | 7. SYNC button | 8. Navigation buttons | 9. SET button | 10. Power switch

Operation

Rear Panel

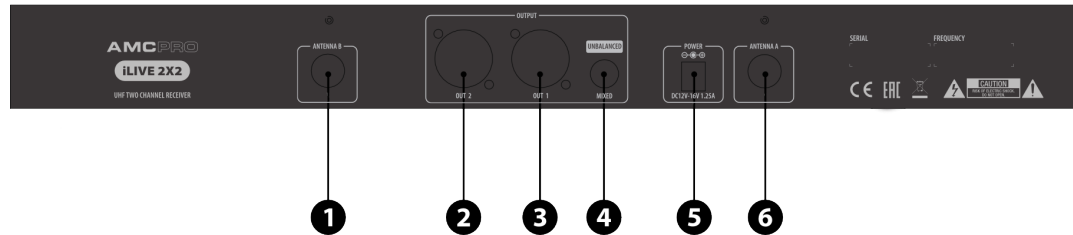

1. Antenna A connector | 2. XLR audio output from second receiver | 3. XLR audio output from first receiver
4. Mixed audio output | 5. Main power connector | 6. Antenna B connector

Operation

Handheld microphone

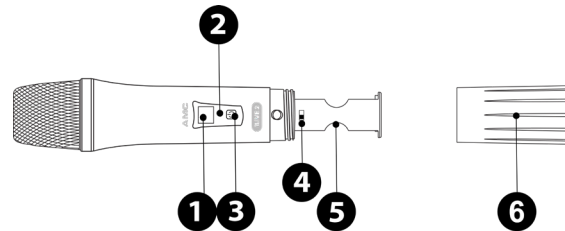

1. LCD display | 2. IR receiver | 3. Power button | 4. RF power selector | 5. Battery holder | 6. Battery cover

Body pack

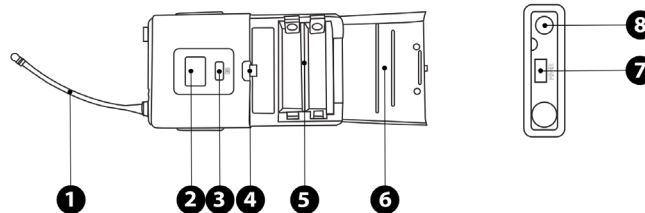

1. Antenna | 2. LCD display | 3. IR receiver | 4. Battery cover lock | 5. Battery holder | 6. Battery cover | 7. Power button | 8. Microphone connector



Operation

Receiver operation

SYNC BUTTON

Press this button to transmit data from receiver to transmitter in order to synchronize microphone or body pack transmitter and receiver.

NAVIGATION BUTTONS

These buttons are designed to navigate receivers menu and adjust settings.

SET BUTTON

Short press of this button shows number of current channel for two seconds on LCD screen if channel frequency are displayed for default and otherwise, shows the channel frequency if channel number are set for display default. Long press brings menu on the screen, in order to enter the submenu press SET button one more time. Use navigation buttons to navigate menu or adjust settings.

LCD DISPLAY

Displays the current settings, menu and other information, like RF level, AF level, volume, frequency or channel, lock status, mute status and which antenna A or B is active at the moment.

IR TRANSMITTER

IR transmitter allows synchronizing microphone or body pack and receiver by establishing handheld microphone or body pack radio frequency to the same as the receiver.

POWER SWITCH

Press power switch for 3 seconds to turn on/off the power.

ANTENNA CONNECTOR

This connector designed to connect antenna to the receiver.

XLR AUDIO OUTPUT

Balanced XLR audio output.

MIXED AUDIO OUTPUT

Unbalanced audio output, 6.3mm TS jack connector. Audio signal in this output is mixed from both receivers.

MAIN POWER CONNECTOR

Connector for DC 12 V – 16 V 1.25A power supply.

Handheld microphone operation

LCD DISPLAY

Displays the current frequency, channel and transmitter's battery level.

IR RECEIVER

IR receiver allows synchronizing microphone and receiver by establishing handheld microphone radio frequency to the same as set in receiver.



Operation

POWER BUTTON

Press power button for 3 seconds to turn on/off the power.

BATTERY HOLDER

Battery holder for two pieces of AA sizes alkaline batteries. **Pay attention to battery polarity, wrong polarity can damage transmitter!**

BATTERY COVER

Remove battery cover in order to insert or replays batteries.

Body pack transmitter operation

ANTENNA

Antennas for RF signal transmitting to the receiver. Covered antenna can reduce working distance, try to keep antenna uncovered in order to guaranty maximum working distance.

LCD DISPLAY

Displays the current frequency, channel and low battery indication.

IR RECEIVER

IR receiver allows synchronize body pack and receiver by establishing body pack radio frequency to the same as set in receiver.

BATTERY COVER LOCK

Push cover lock in order to remove battery cover.

BATTERY HOLDER

Battery holder for two pieces of AA sizes alkaline batteries. **Pay attention to battery polarity, wrong polarity can damage transmitter!**

BATTERY COVER

Remove battery cover in order to insert or replays batteries.

POWER BUTTON

Press power button for 3 seconds to turn on/off the power.

MICROPHONE CONNECTOR

Balanced XLR and unbalanced 6,3mm Jack audio output.

Operation

Synchronization

Press infrared data transfer button (SYNC) on the first or second receivers to transmit data from receiver to transmitter in order to synchronize microphone and receiver radio frequency with you desired receiver's side.

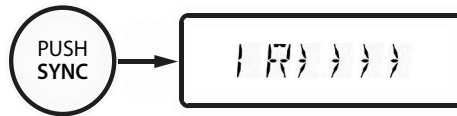

The distance between the devices should be proximally 20cm.



IMPORTANT: During synchronization IR receiver and IR transmitter should be directed to each other.

Operation

Receiver's menu

Long press of SET button brings main menu on the screen, in order to enter the submenu press SET button one more time. Use navigation buttons to navigate menu and adjust settings.

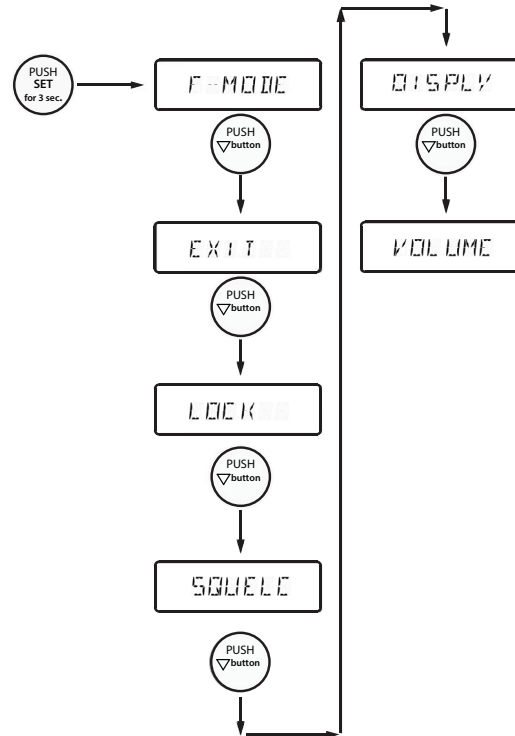

Operation

F-MODE MENU

Activate F-mode menu by pressing SET button for 3 sec. This menu consists from TUNE, CHANNEL and EXIT sub menu.

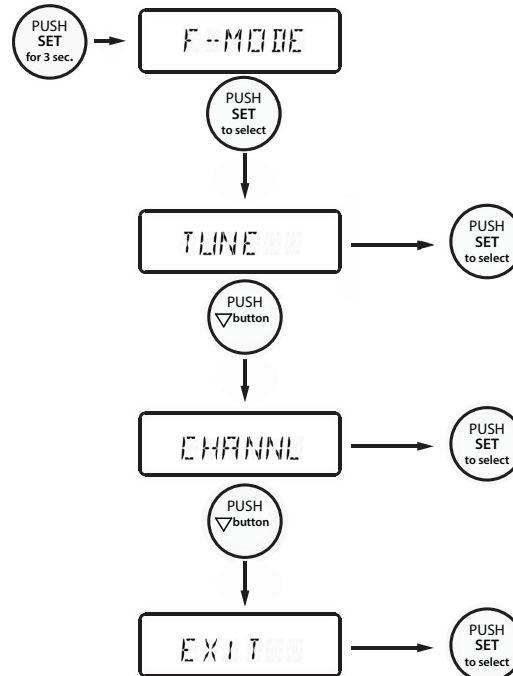

Operation

TUNE MENU

Select tune menu in order to change manually receiver's frequency in 50 kHz steps.

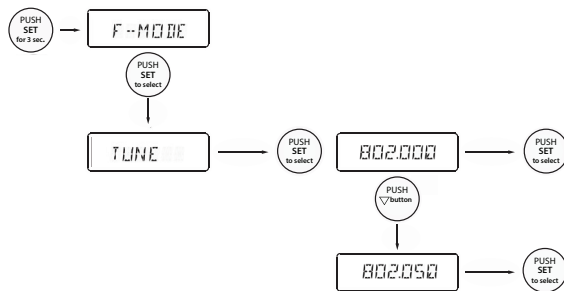

CHANNEL MENU

Select CHANNEL to set one of the 32 channel's presets. Before the selecting CHANNEL, the default display in the DISPLY menu should be set to CHANNEL.

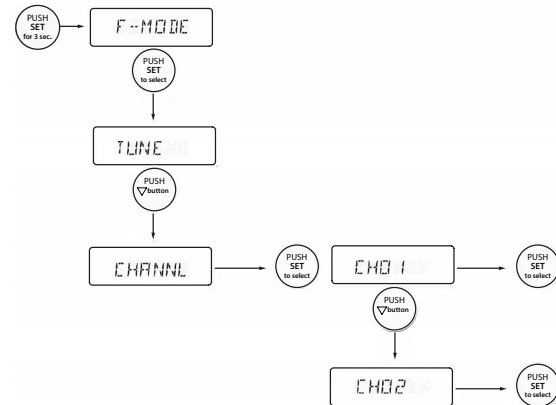

Operation

DISPLAY MENU

Display menu allows to change the default screen view from frequency to channel and otherwise. Select "CHANNL" to display channel number in the screen or select "FREQUE" to display channel frequency in Mhz.

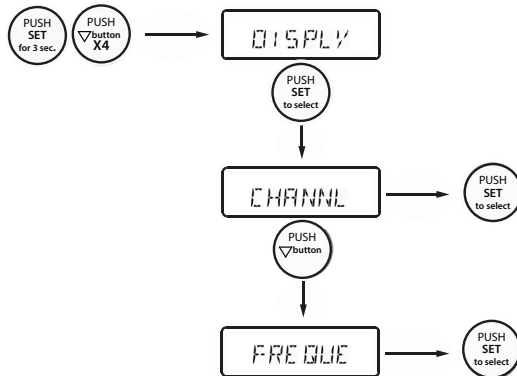

SQUELCH MENU

The squelch level is adjustable in 5dB steps from 0dB to 20dB. Selecting a smaller value increase the squelch threshold, selecting a higher value reduce the squelch threshold. If the squelch threshold is set too high, the microphone working distance can be reduced.

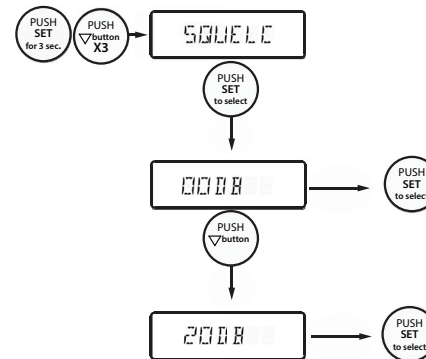

Operation

VOLUME MENU

Select VOLUME menu to adjust audio output level.

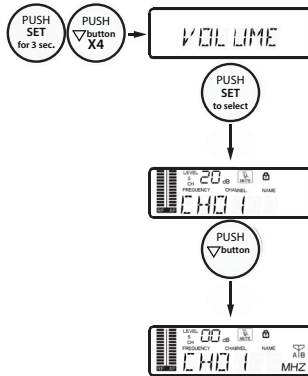

EXIT MENU

Select to exit from menu.



LOCK MENU

Lock menu allows lock main panel buttons, except power and SETTING buttons. Please set lock function to off, for unlock.

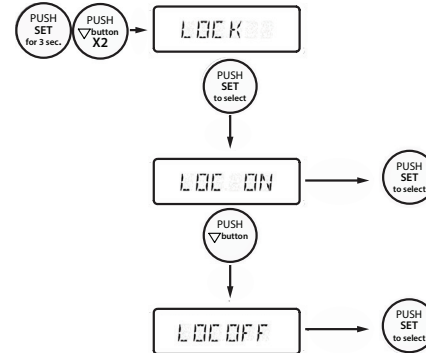

Specifications

GENERAL

iLIVE 2x2 receiver

Power supply	12-15 V DC, 1.25 A
Output	2 x Balanced XLR, 1 x unbalanced 6,3 mm TS JACK
Receiver way	Two frequency conversion super-heterodynes
Intermediate frequency	10,7 MHz
Antenna	BNC
T.H.D	< 0,7 %
Sensitivity	6 dB μ V
Image rejection	36 dB
Max. audio output	0 dB
Dimensions (H x W x D)	420 mm X 44 mm X 183 mm
Weight	2.3 kg
Material	Steel enclosure, aluminum front panel

iLIVE 2 handheld transmitter

Carrier frequency range	606 MHz - 621 MHz
Modulation	FM
Channels	32
Audio frequency response	45 Hz - 18 kHz
S/N ratio	> 105 dB
Antenna	Built-in spiral antenna
Transmitter's power	3 mW
Working range	60 m (Note: actual range depends on RF signal absorption, reflection and interference)
Polar pattern	Cardioid
Battery	2 x 1,5 V AA Alkaline battery
Dimensions	240 mm (length)
Weight	302 g
Material	Aluminum

Specifications

GENERAL

iLIVE 2 body pack transmitter

Carrier frequency range	606 MHz - 621 MHz
Modulation	FM
Channels	32
Audio frequency response	45 Hz - 18 kHz
S/N ratio	> 105 dB
Antenna	1/4 wave antenna
Input connector	4 pin mini XLR connector
Transmitter's power	3 mW
Working range	60 m (Note: actual range depends on RF signal absorption, reflection and interference)
Polar pattern	Cardioid
Battery	2 x 1,5 V AA Alkaline battery
Dimensions	110 mm x 64 mm x 25 mm
Weight	76 g
Material	Plastic



Specifications

GENERAL

	HM
Capsule type	Condenser
Impedance	200 Ω
Sensitivity	-47 dB
Frequency	45 Hz - 18 kHz
Connectors	4 pin mini XLR connector
Phantom power voltage	5V DC
Cable length	1 m
Weight	15 g
Colour	Skin (RAL 1014)
Accessories	Windscreen

	LM
Capsule type	Condenser
Impedance	200 Ω
Sensitivity	-46 dB
Frequency	50 Hz - 18 kHz
Connectors	4 pin mini XLR connector
Phantom power voltage	5 V DC
Cable length	1 m
Weight	21 g
Colour	Black (RAL 1017)
Accessories	Windscreen

The specifications are correct at the time of printing this manual. For improvement purposes, all specifications for this unit, including design and appearance, are subject to change without prior notice.